

DesignOptions

Overcoat

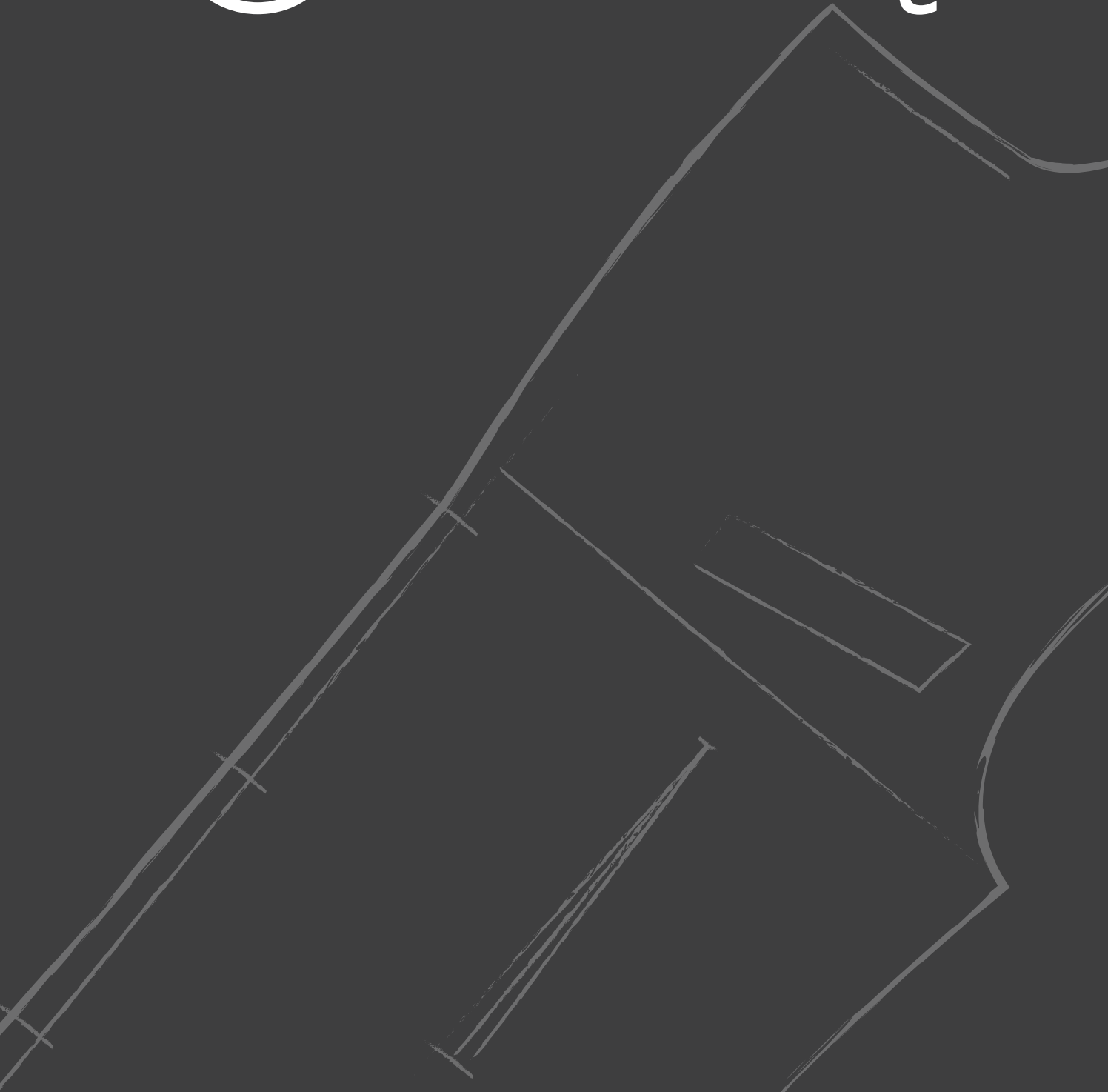

Make

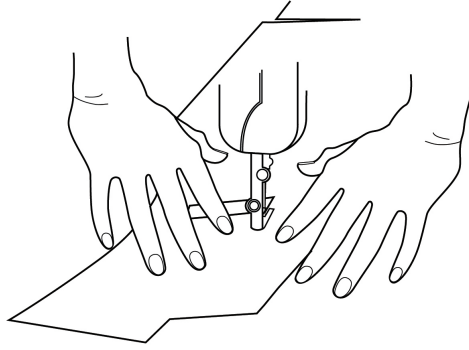

Traditional

Handwork in 'Traditional' make:

- Button attachment
- Collar attachment
- Bottom lining/facing
- Flower loop

Make

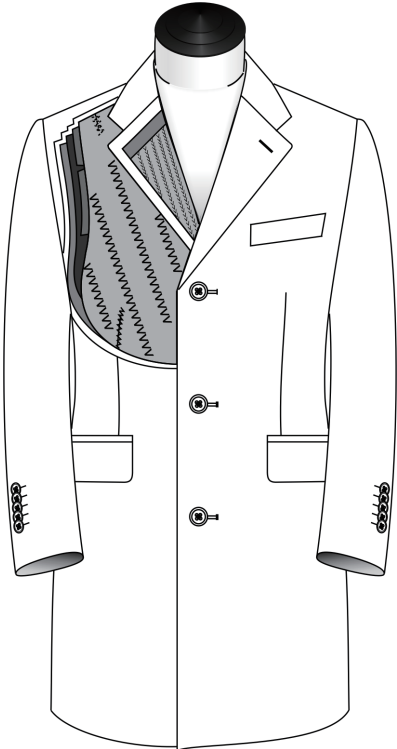

Traditional

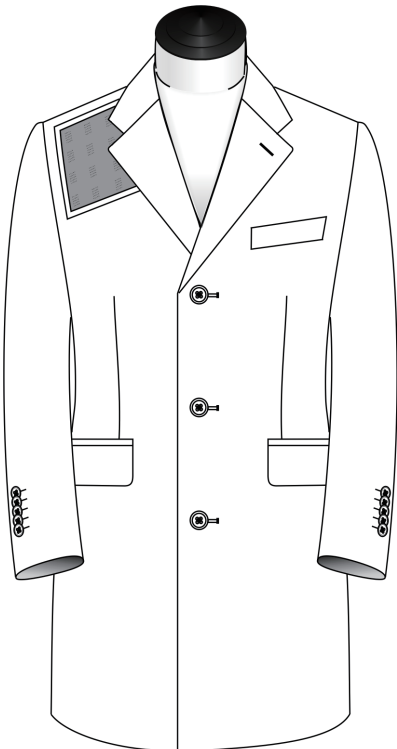
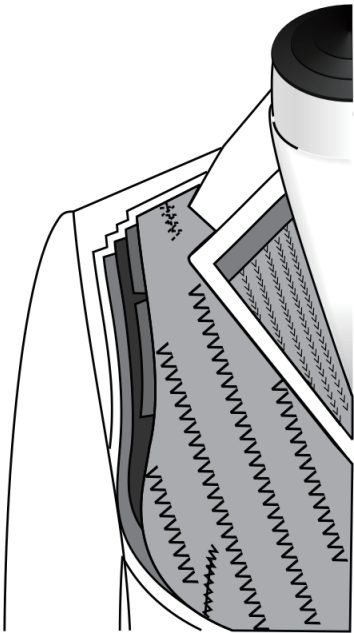

Unconstructed

Closure & Lapel

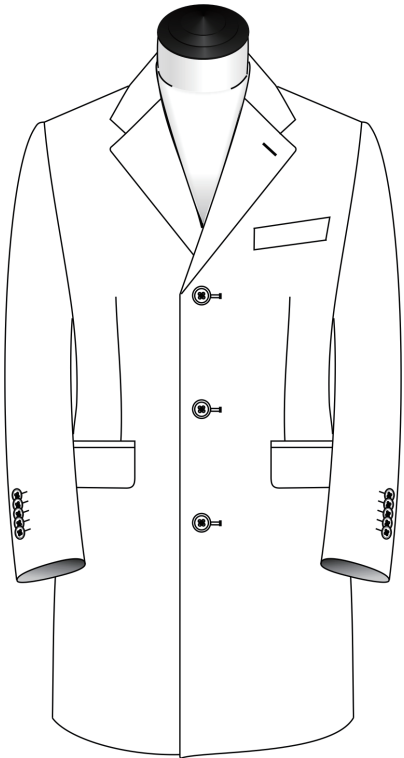

3 Btn Notch Lapel

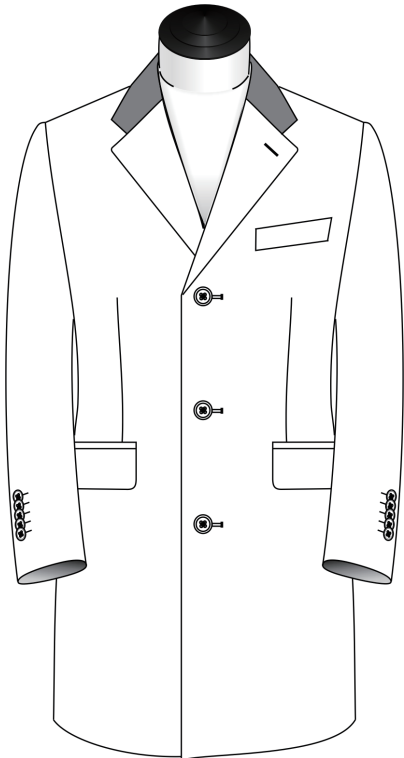

3 Btn Notch Lapel
with Contrast Collar

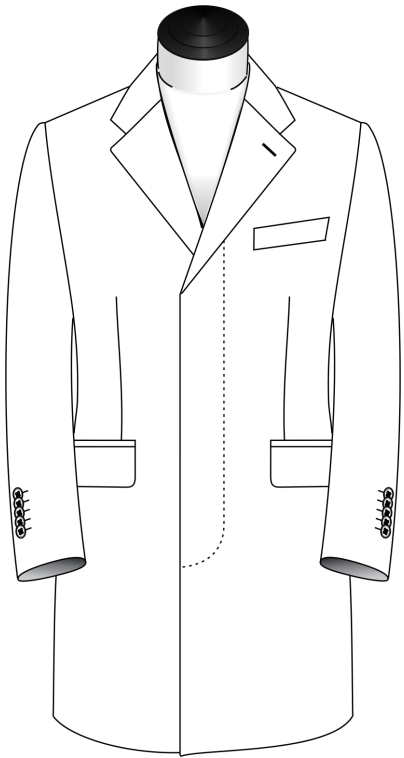

3 Btn Fly Front
with Notch Lapel

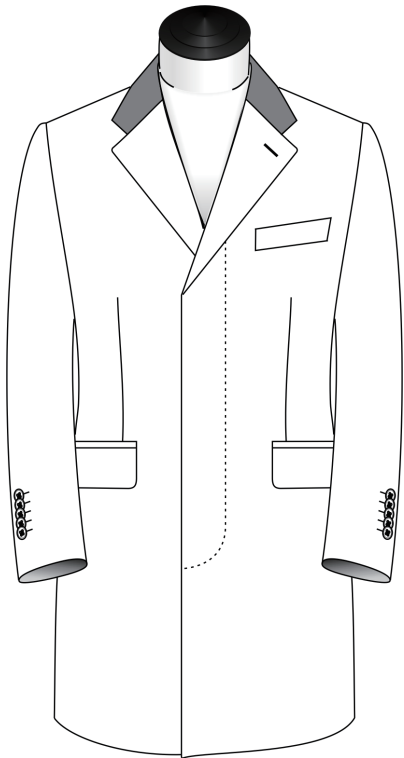

3 Btn Fly Front
with Notch Lapel & Contrast Collar

Closure & Lapel

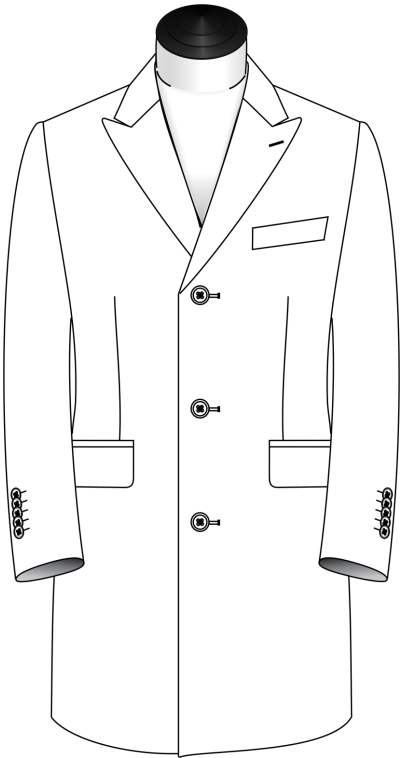

3 Btn with Peak Lapel

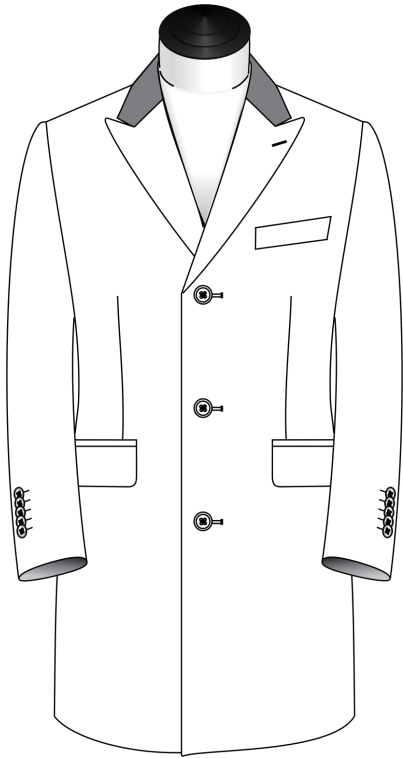

3 Btn with Peak Lapel & Contrast Collar

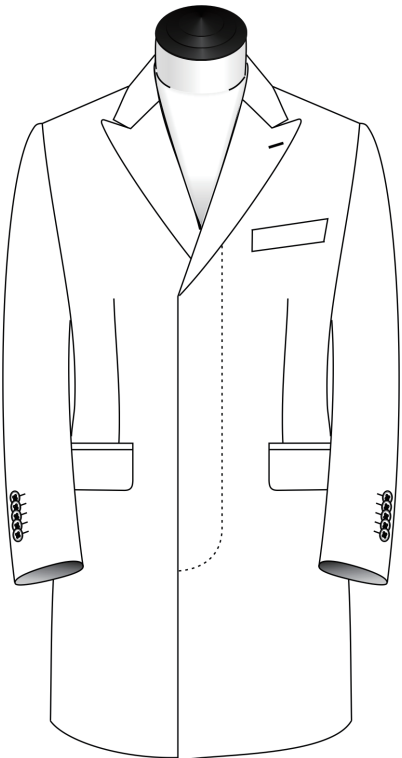

3 Btn Fly Front with Peak Lapel

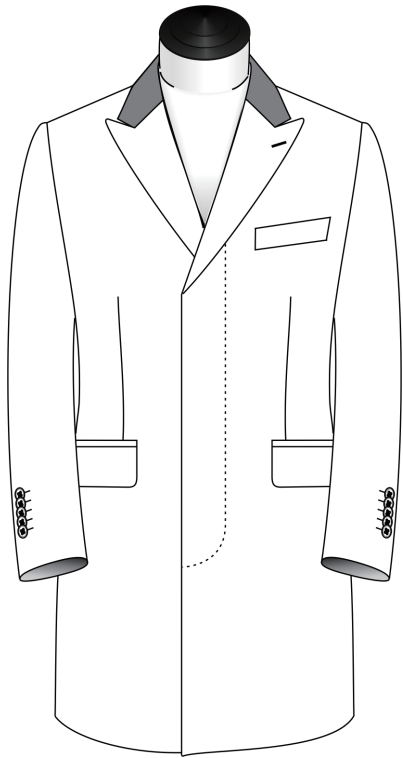

3 Btn Fly Front with Peak Lapel & Contrast Collar

Closure & Lapel

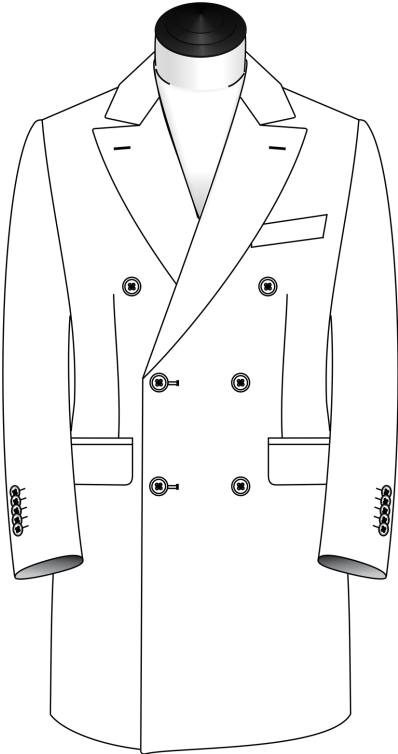

6 Btn Double Breasted

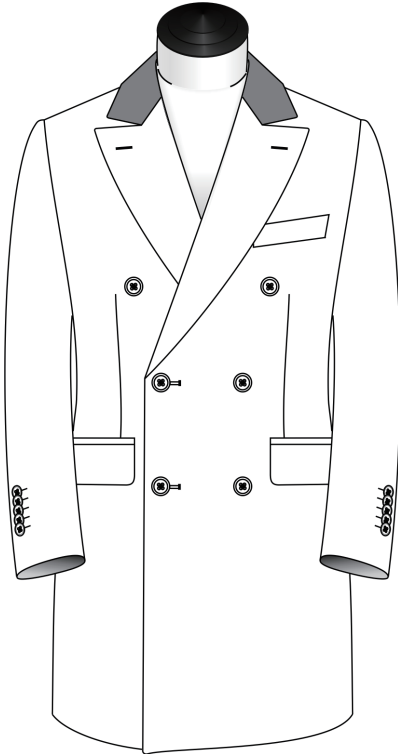

6 Btn Double Breasted with Contrast Collar

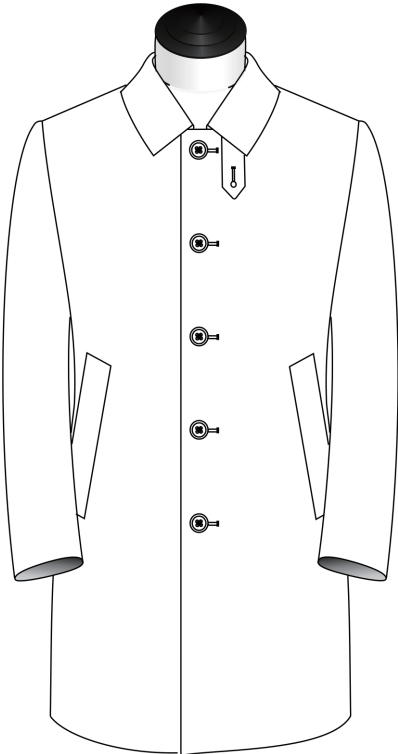

5 Btn Car Coat Collar

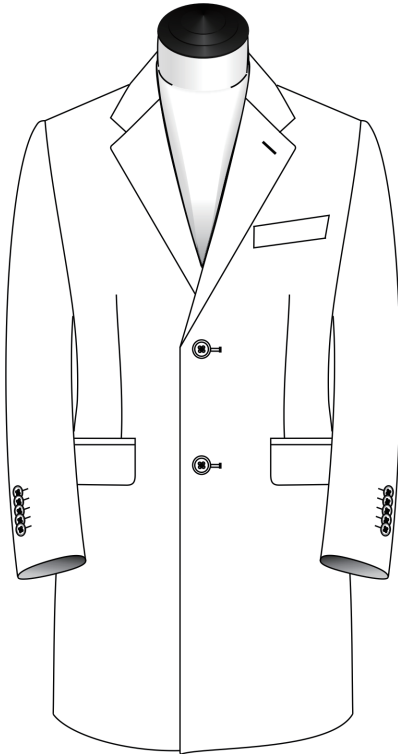

2 Btn Notch Lapel

Closure & Lapel

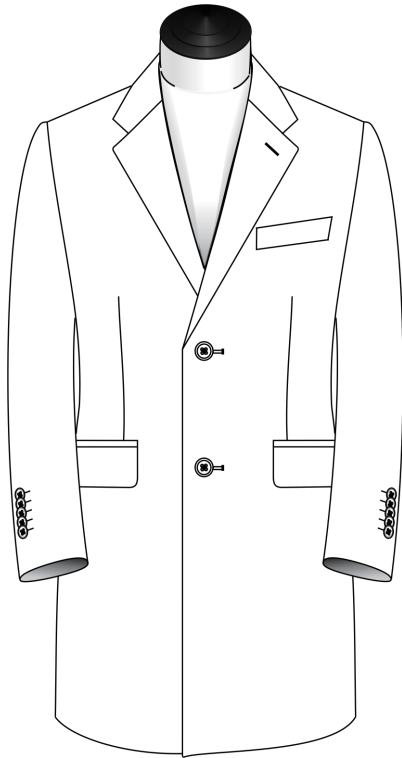

2 Btn Notch Lapel

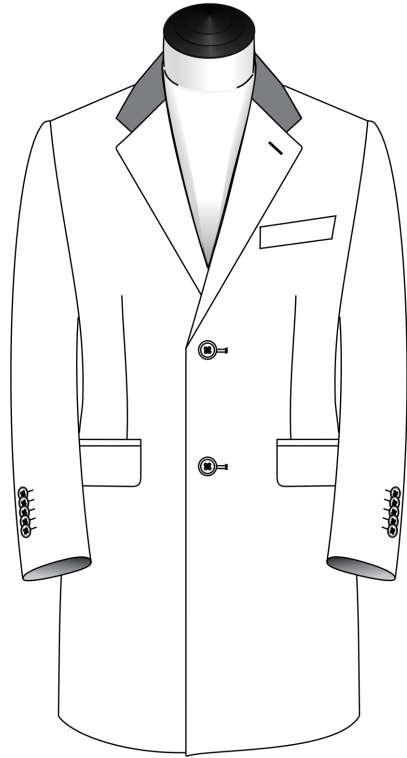

2 Btn Notch Lapel with Contrast Collar

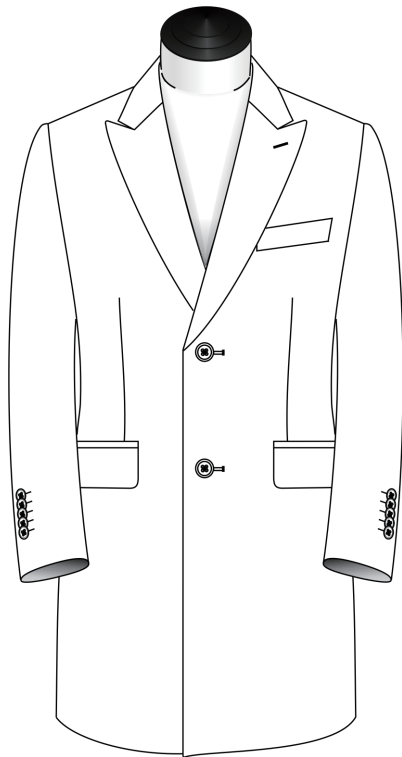

2 Btn with Peak Lapel

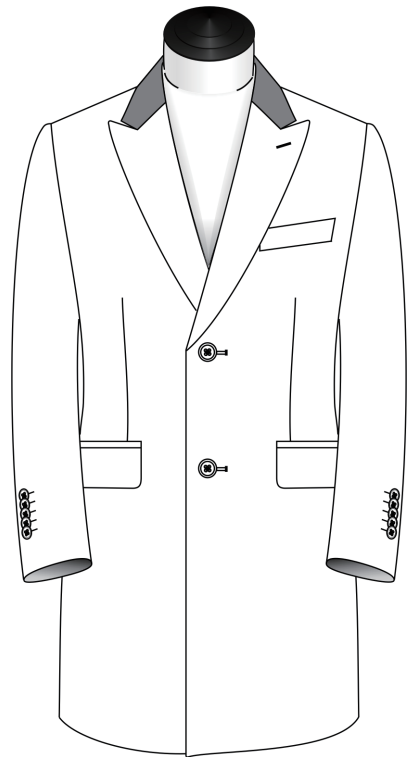

2 Btn with Peak Lapel & Contrast Collar

Closure & Lapel

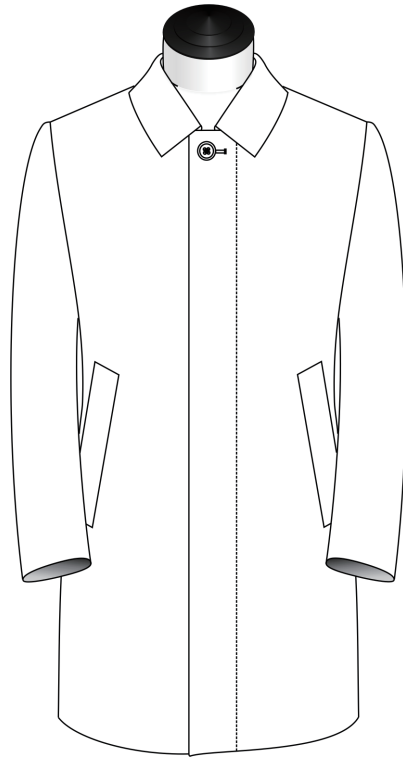

Zipper Closure

Side Pockets

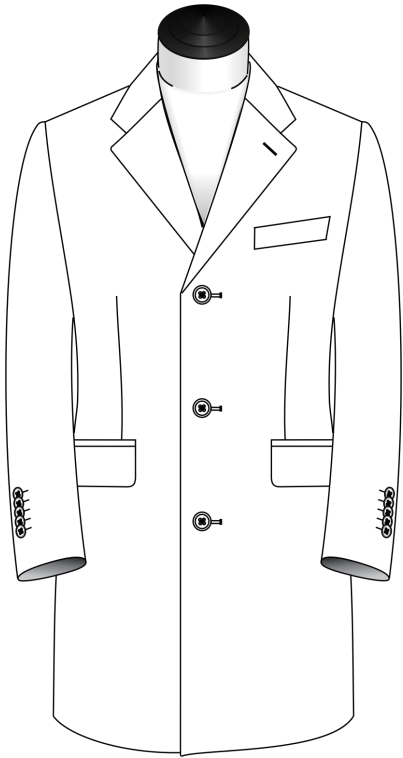

Flap Straight

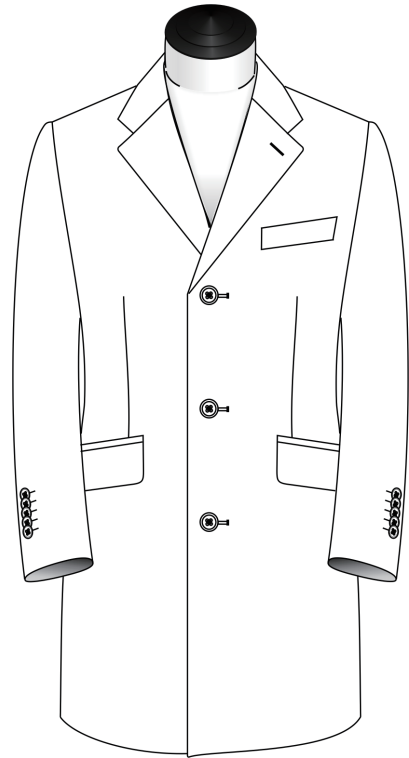

Flap Slanted

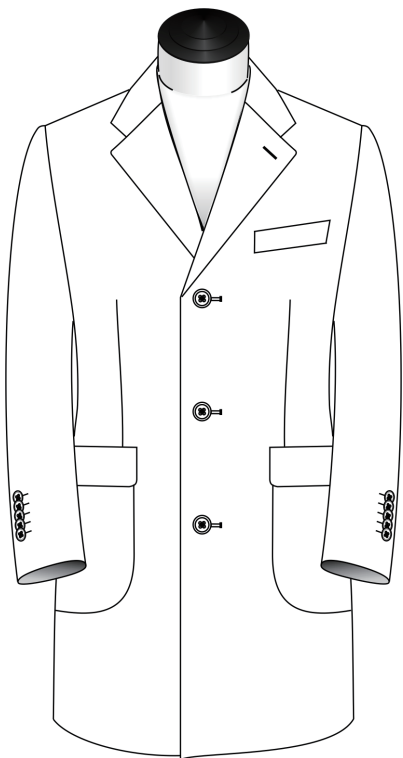

Patch with Flap

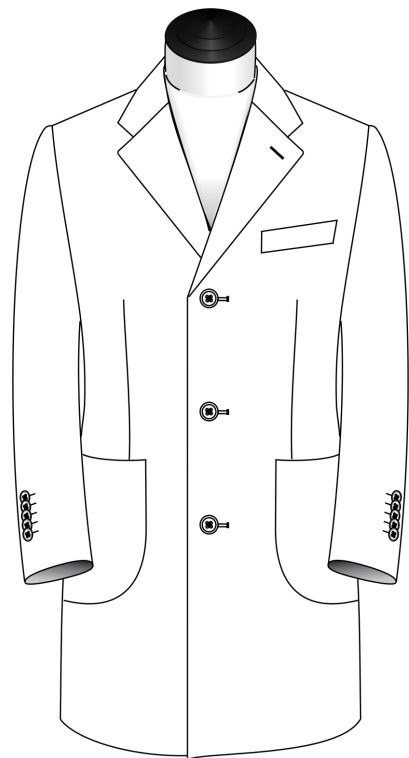

Patch Round

Side Pockets

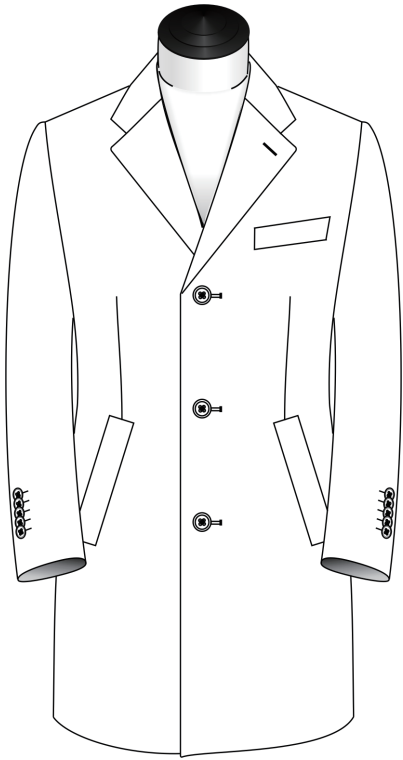

Welted

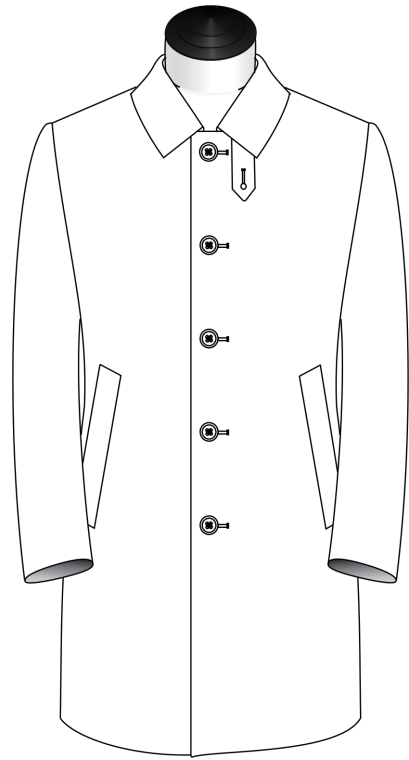

Narrow(4.5cm) Welted

Ticket Pockets

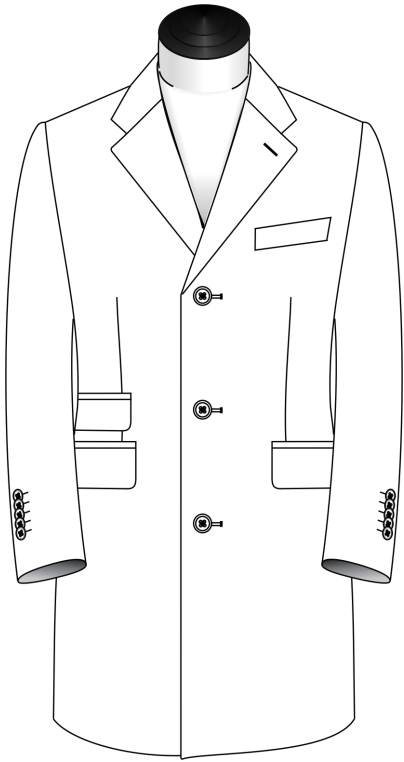

Flap Straight

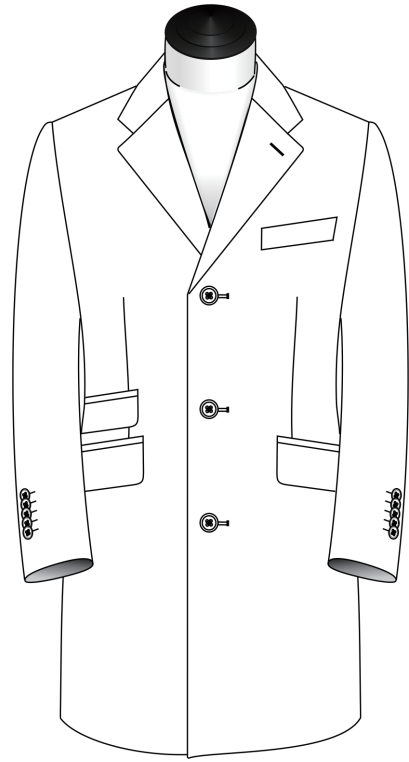

Flap Slanted

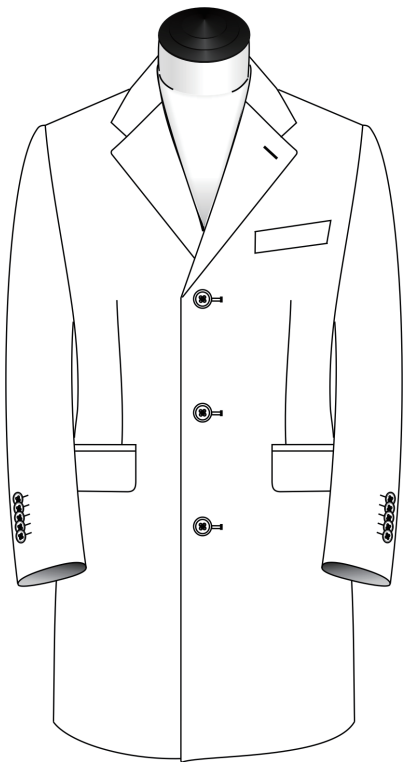

None

Chest Pockets

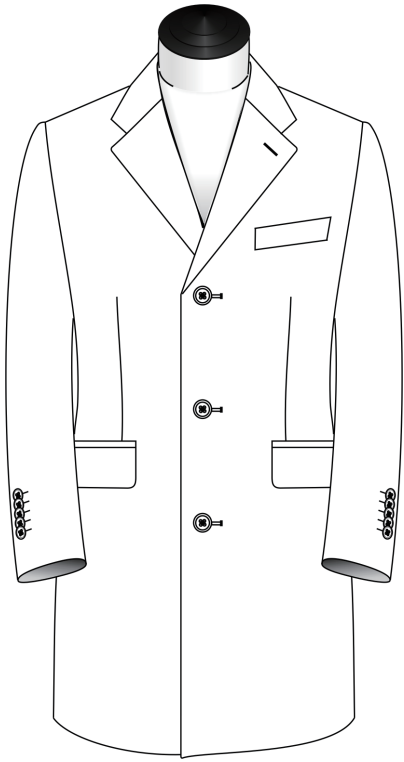

Welted

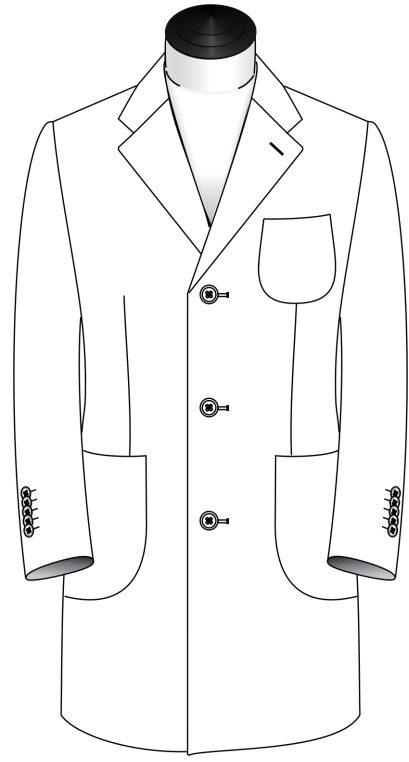

Patch Round

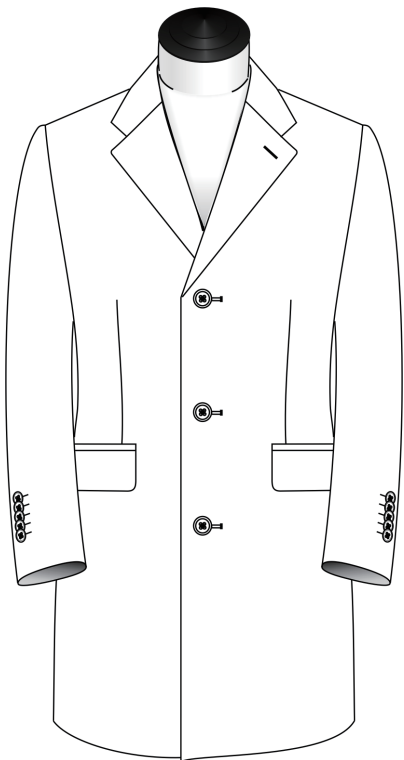

None

Vents

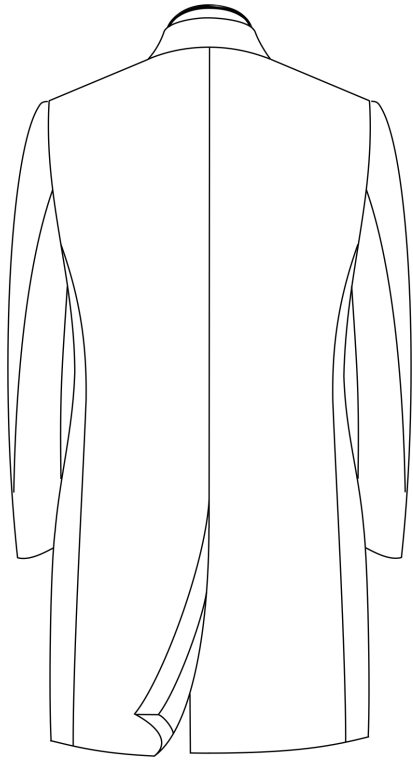

Center [1]

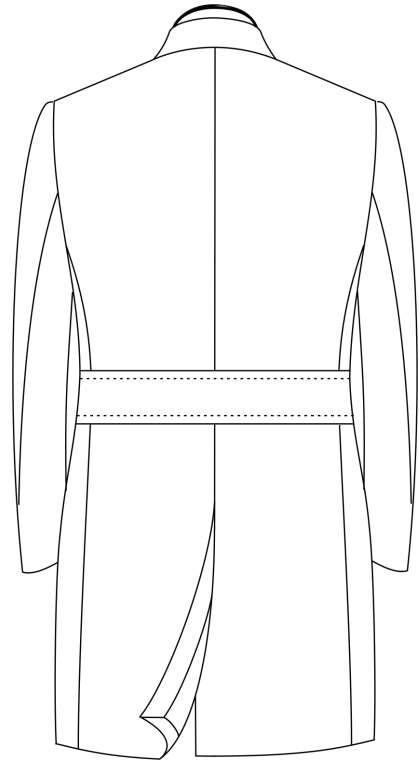

Center [1]
with Back Self Fabric Belt

Cuff Finishing

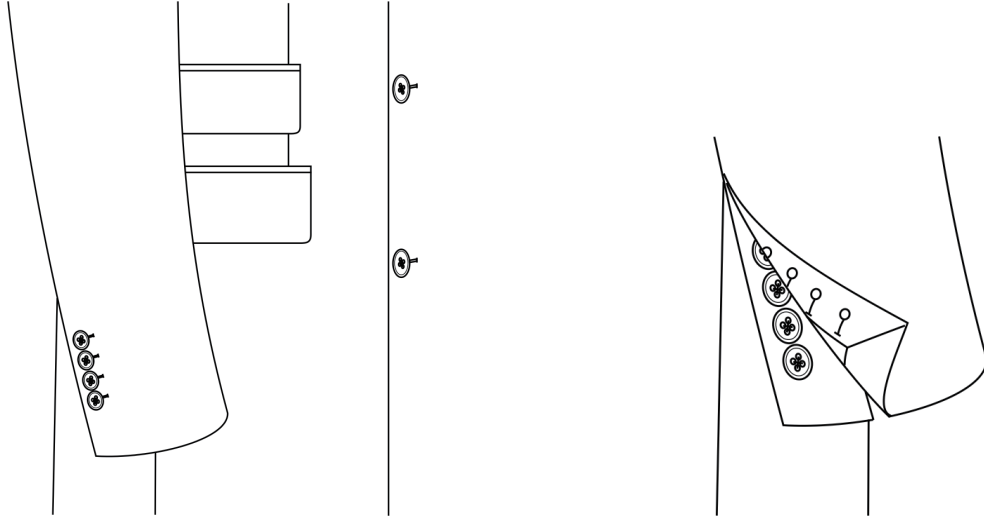

4 Open

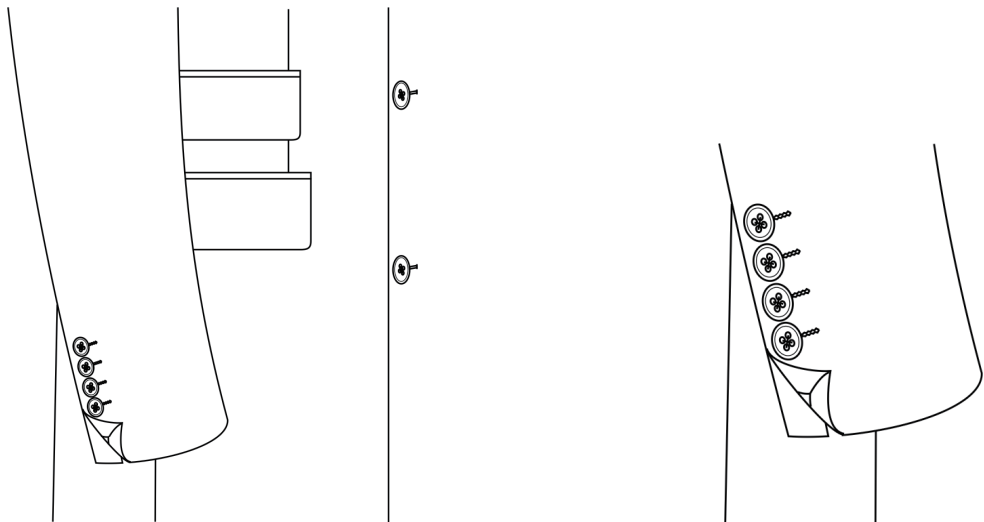

4 Closed

Cuff Finishing

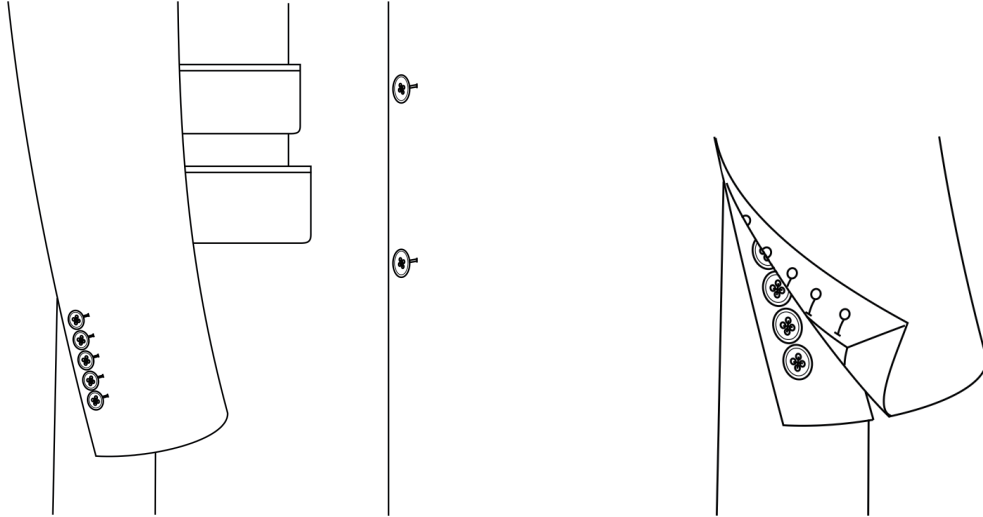

5 Open

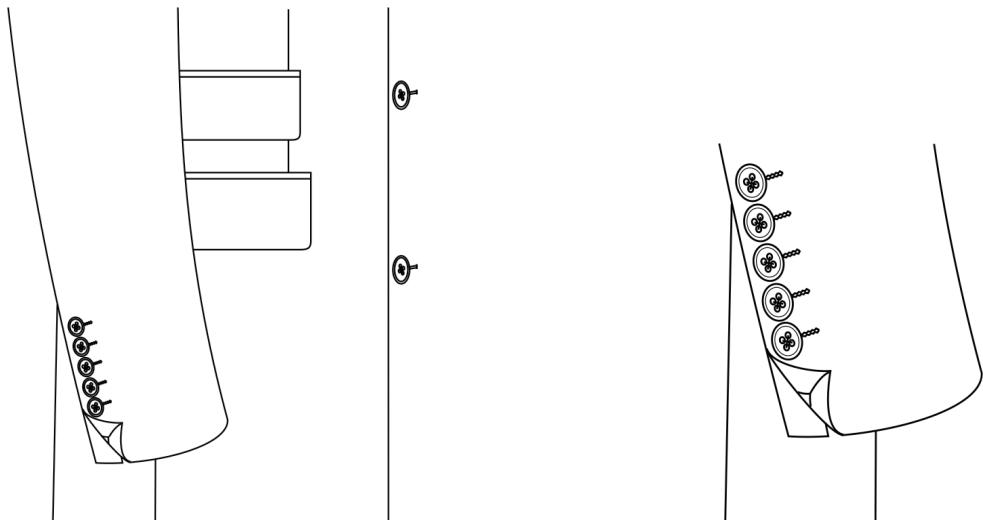

5 Closed

Cuff Finishing

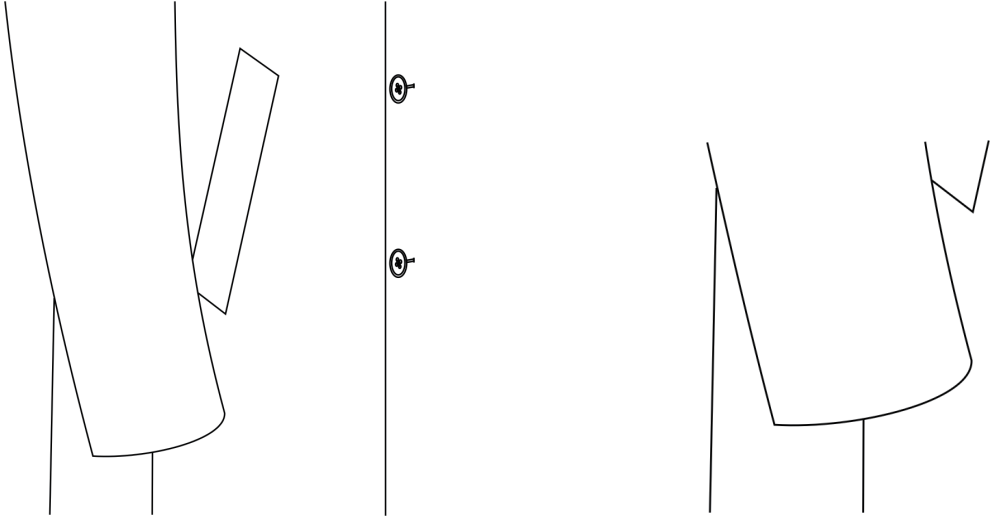

No

Cuff Tab

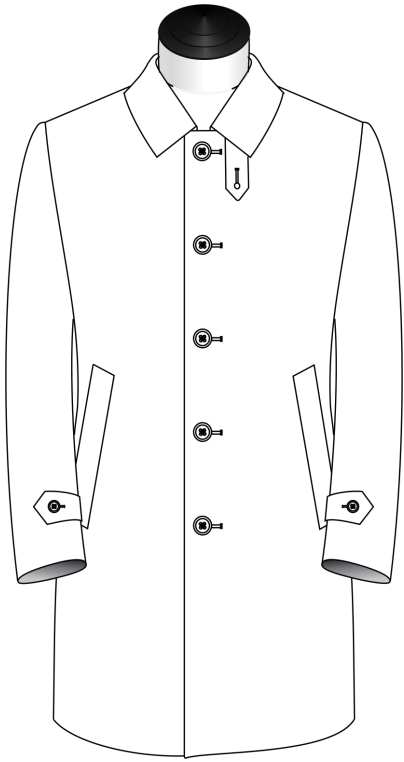

Yes

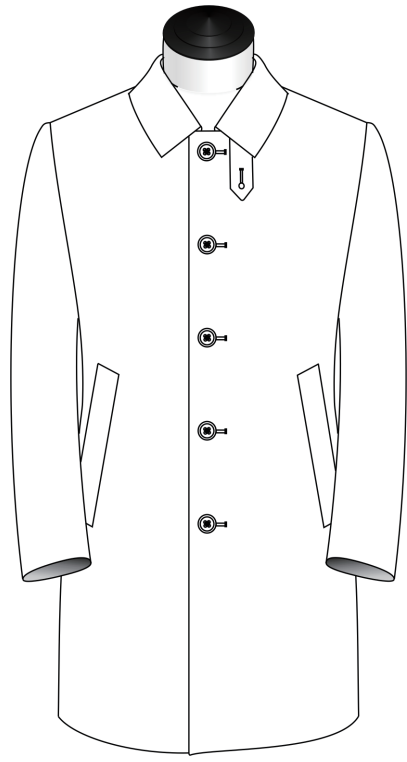

N/A

Sleeve Button Spacing

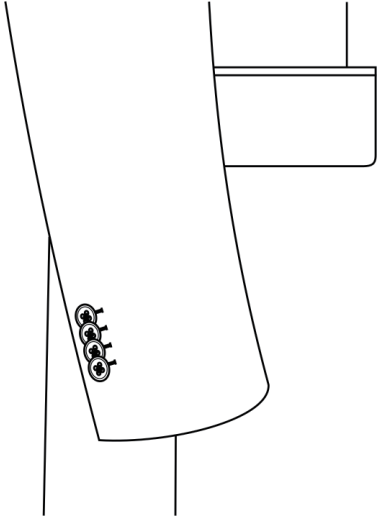

Kissing

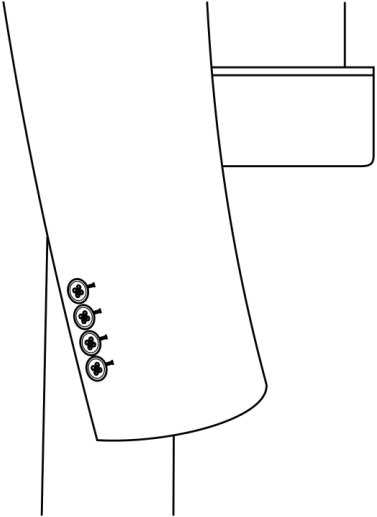

Non Kissing

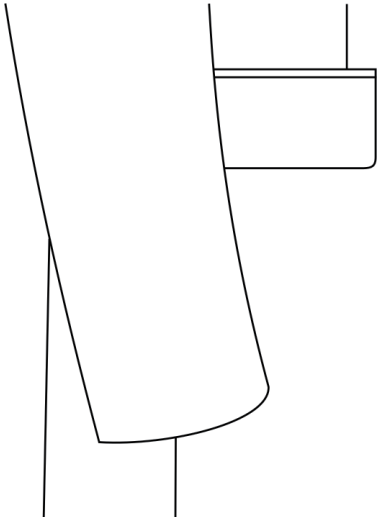

Without Buttonholes

Pick Stitching

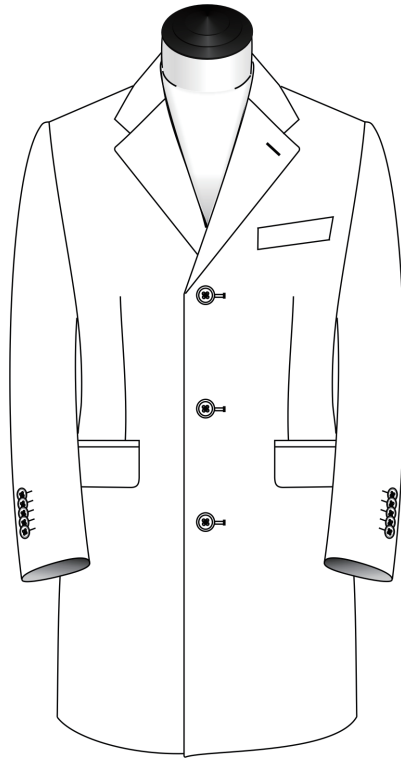

None

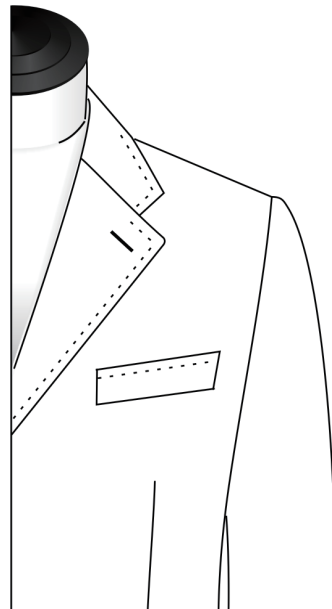
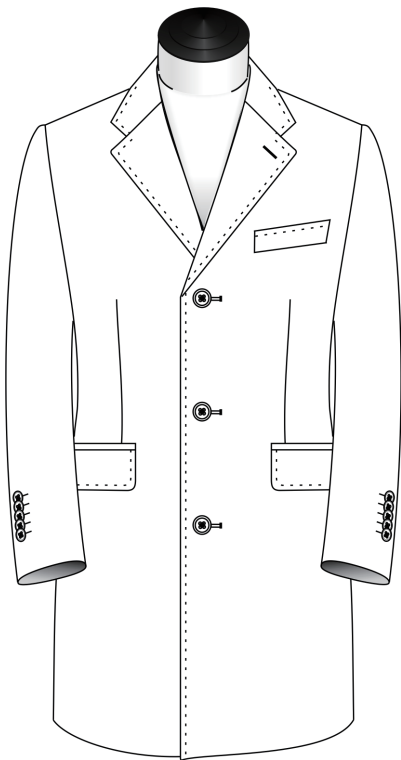

6mm / 1/4in

Pick Stitching

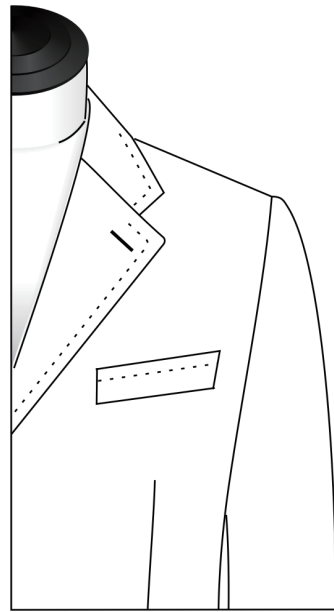
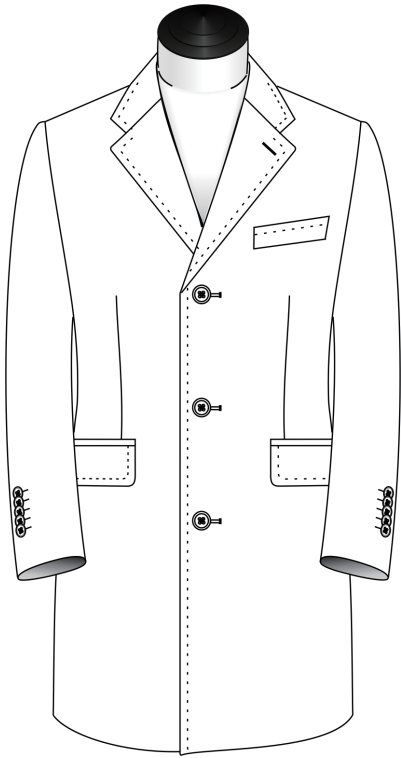

11mm / 1/2in

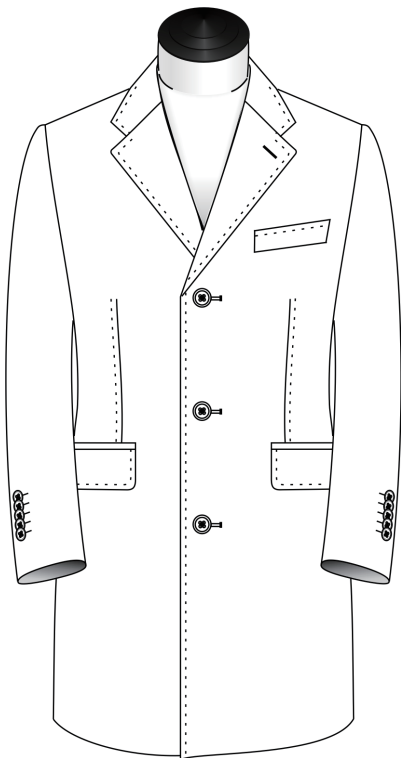

6mm full / 1/4in

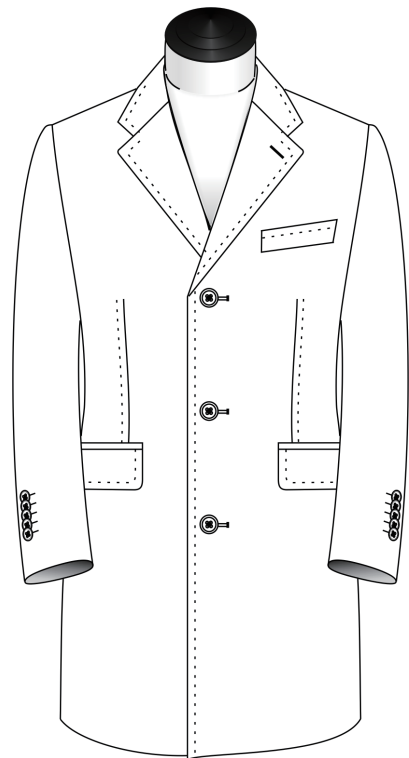

11mm full / 1/2in

Shoulder Type

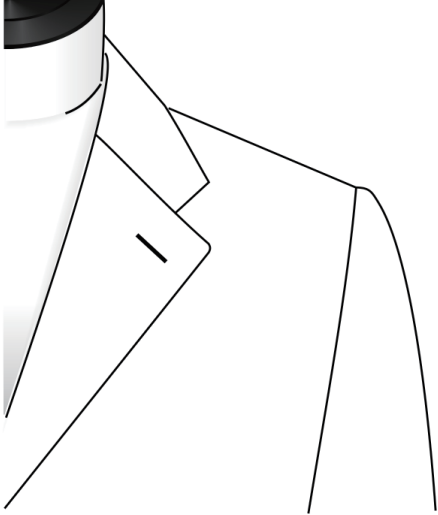

Traditional

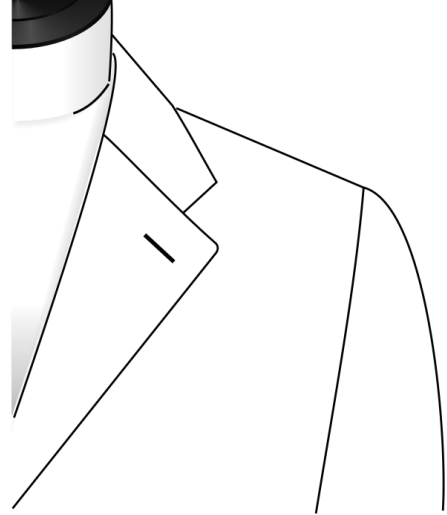

Unconstructed

Shoulder Tab

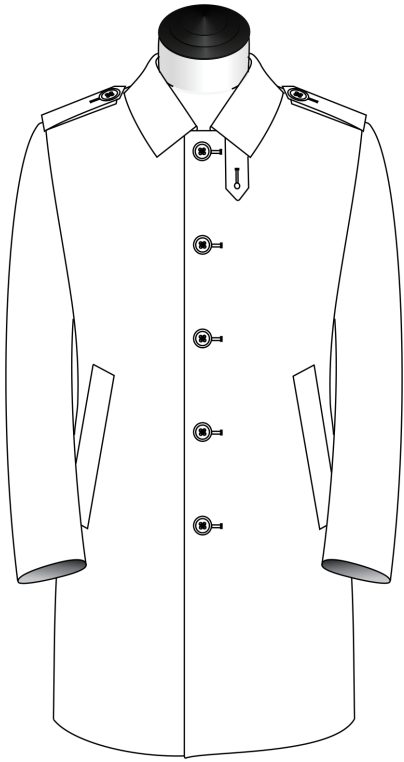

Yes

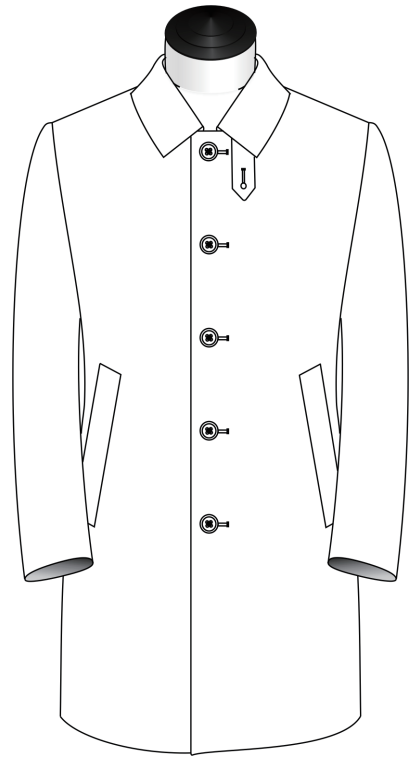

N/A

Interior Construction

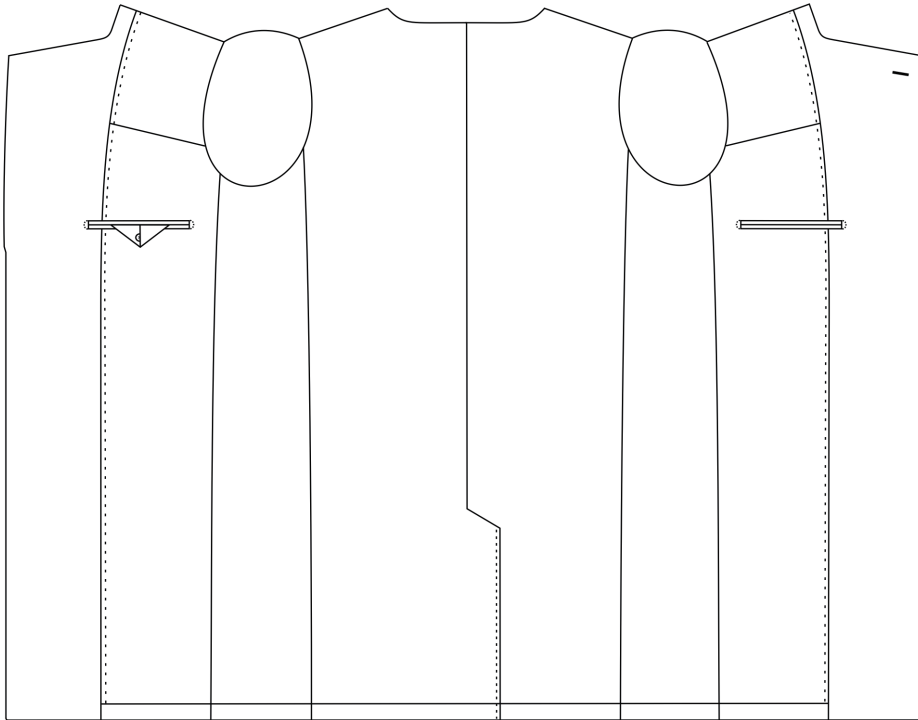

Classic with Fabric Jetted Pockets

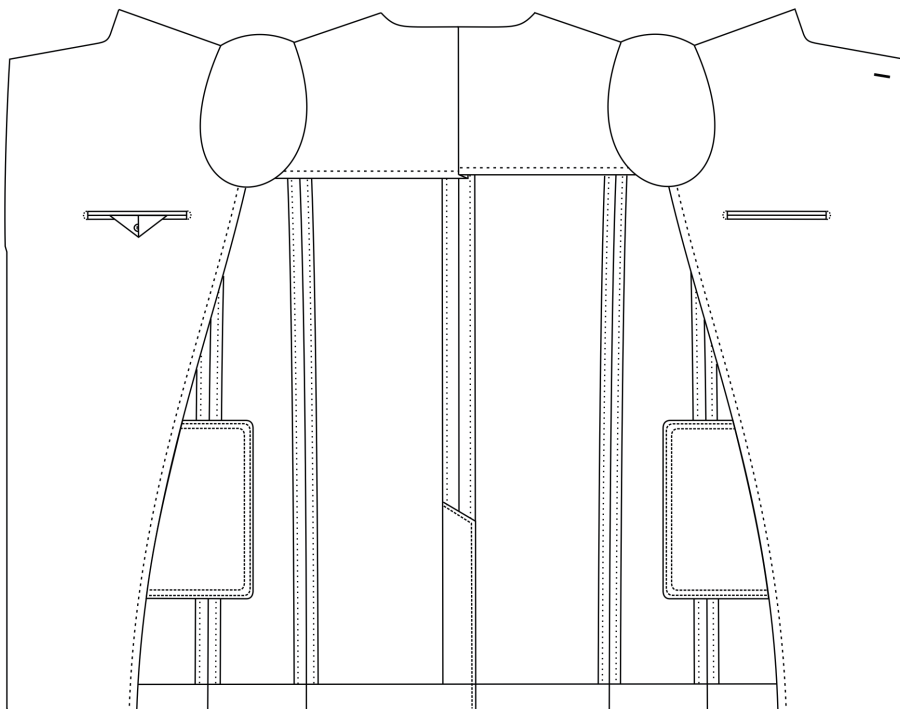

Unlined with Fabric Facing

Mobile Phone Pocket

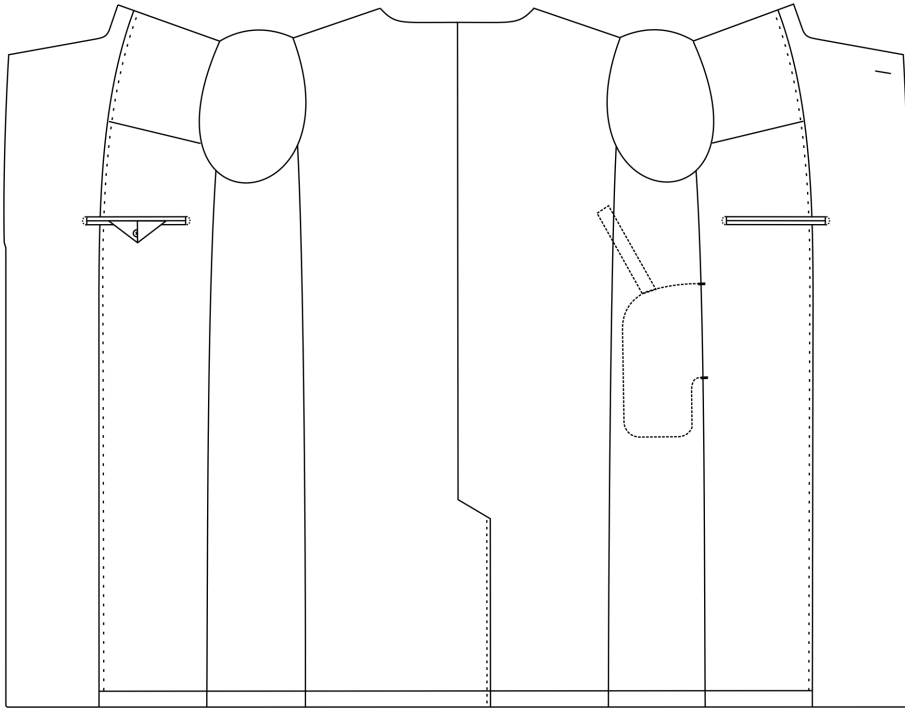

Yes

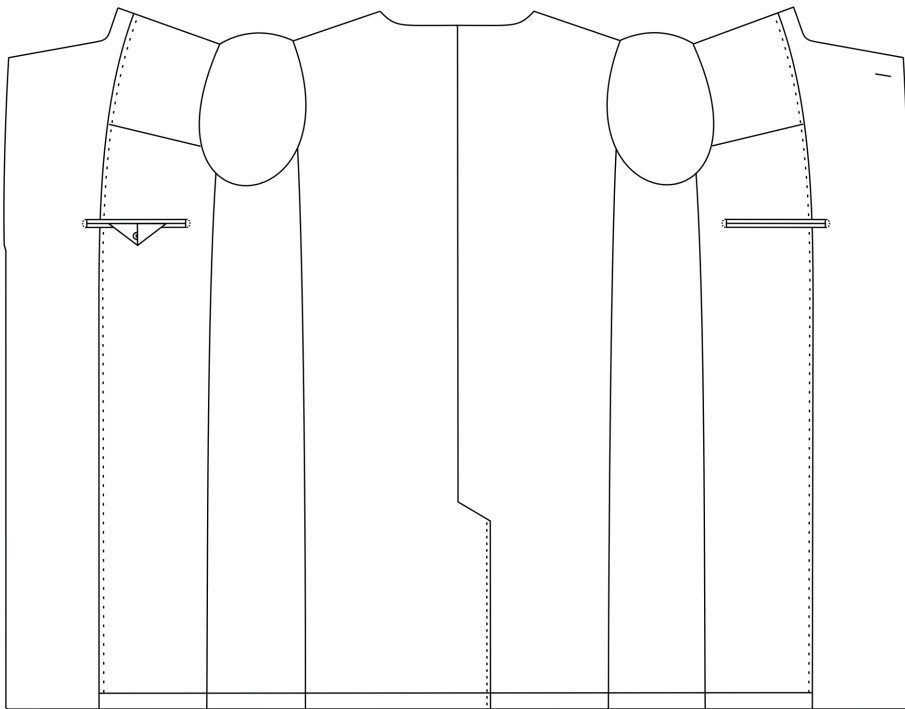

No

Melton Undercollar

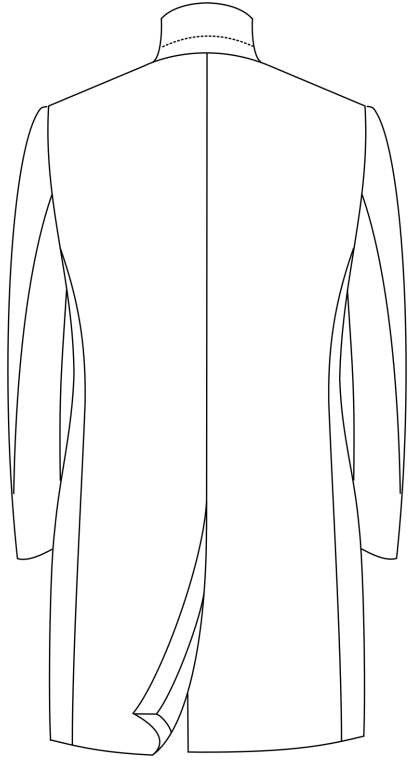

Fabric

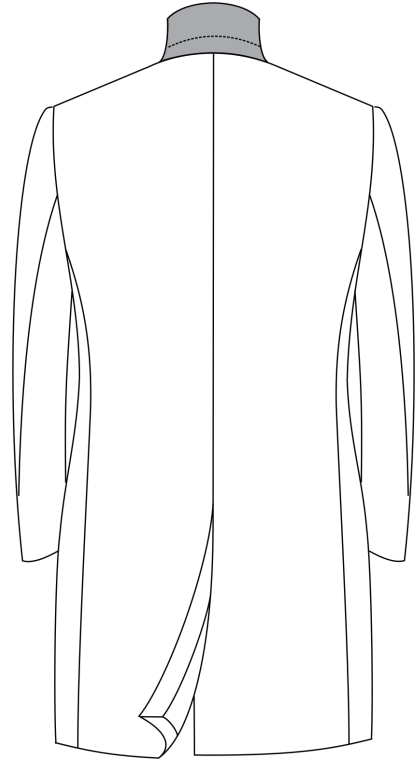

Melton

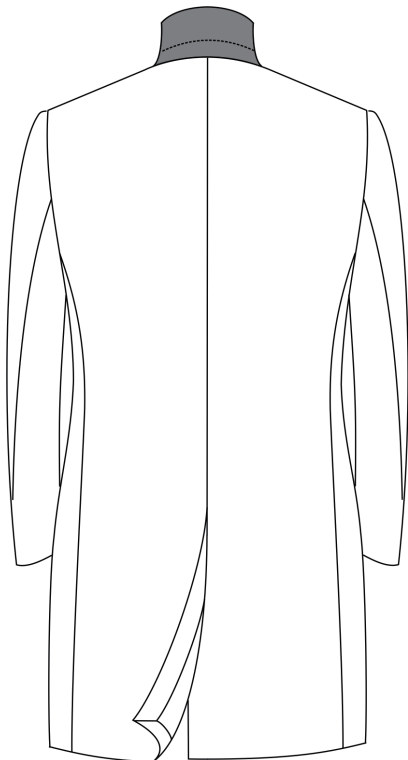

Suede

Monogram Under Collar

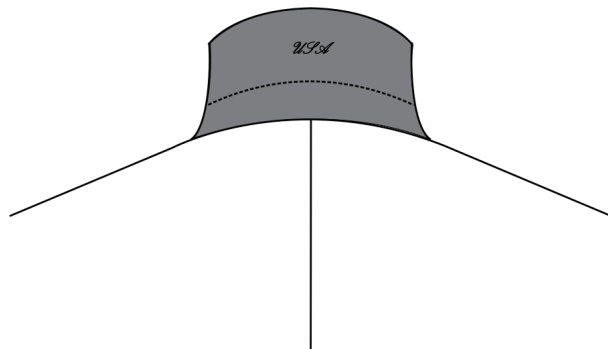
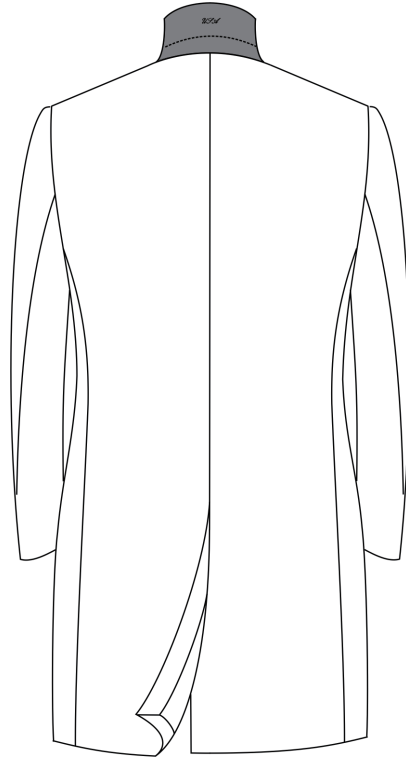

Monogram Interior Position (Monogram on Lining)

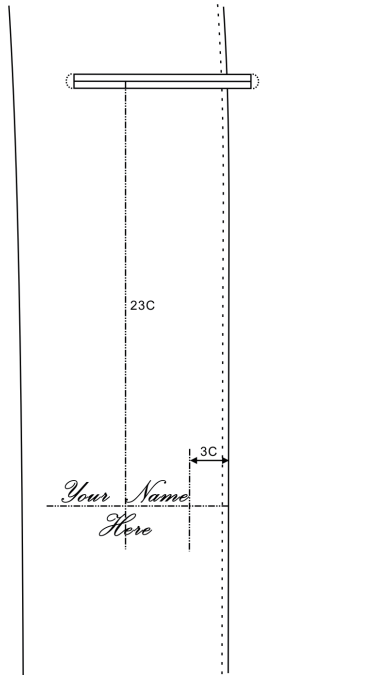

Jet

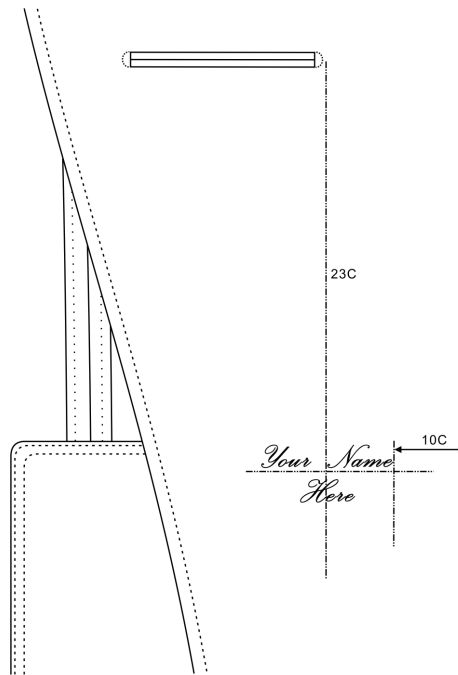

Unlined

Monogram Interior Position (Monogram on Label)

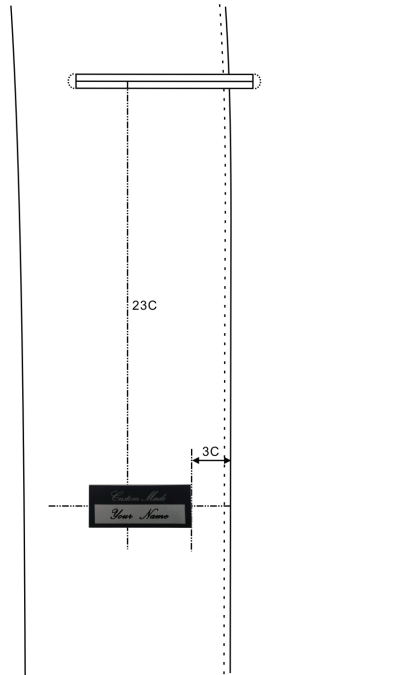

Jet

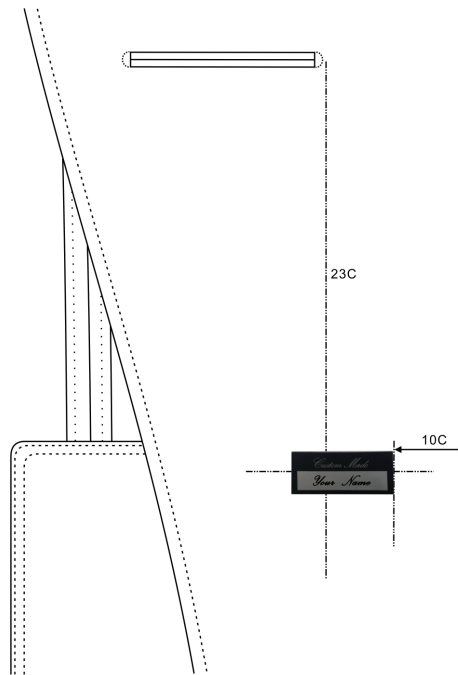

Unlined