

DesignOptions

Trench Coat

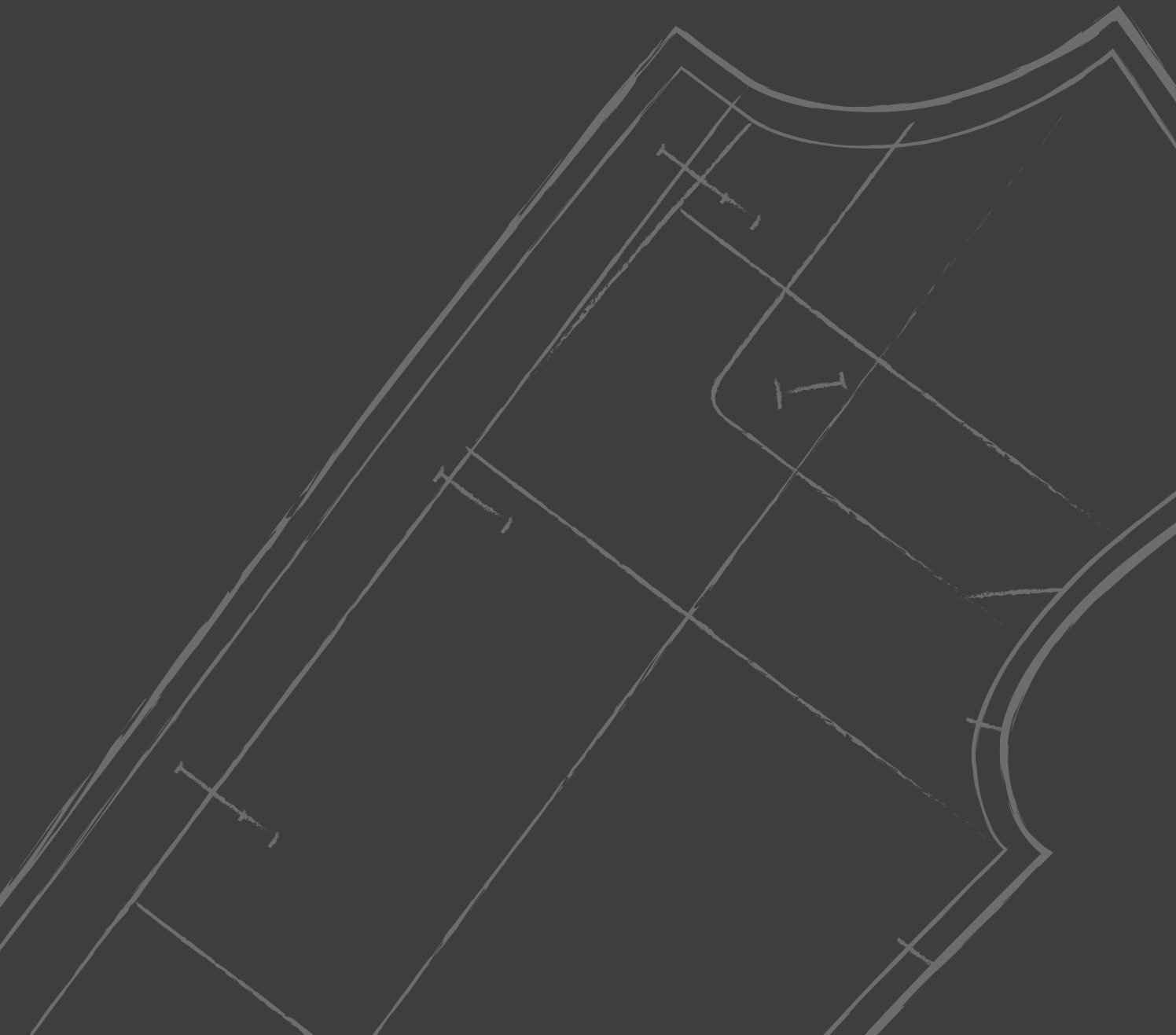

Make

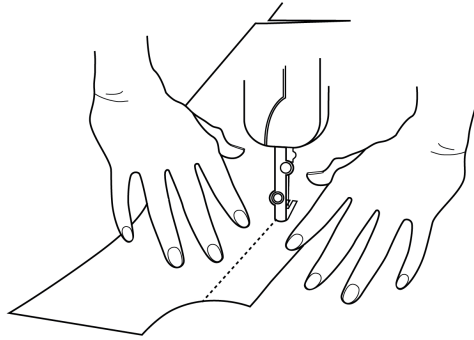

Traditional

Handwork in 'Traditional' make:

Button attachment
Collar attachment
Bottom lining/facing
Flower loop

Closure & Lapel

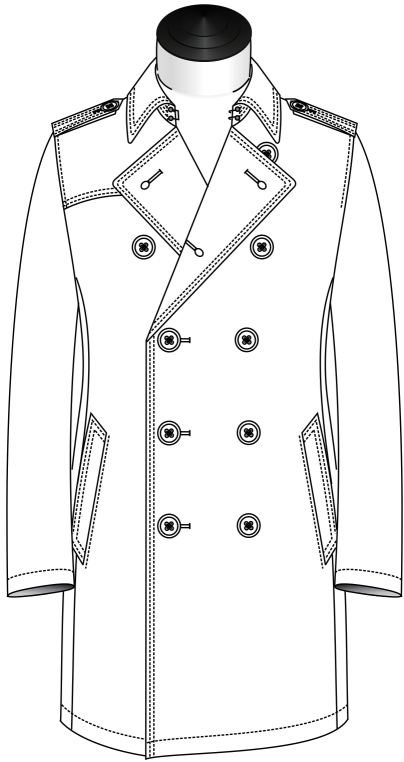

10 Btn DB

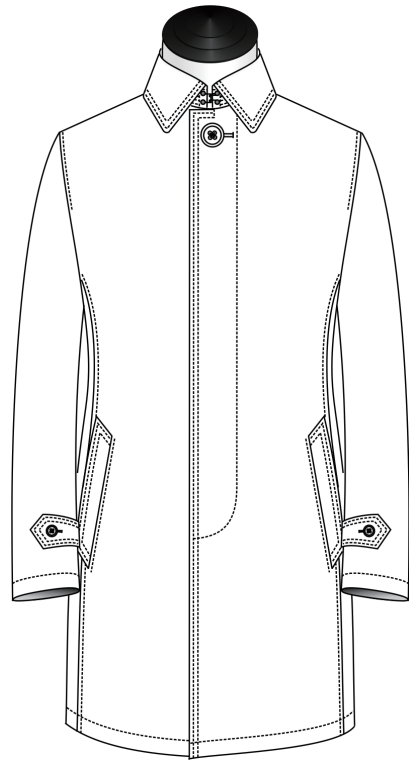

4 Button Fly Front with Car Collar

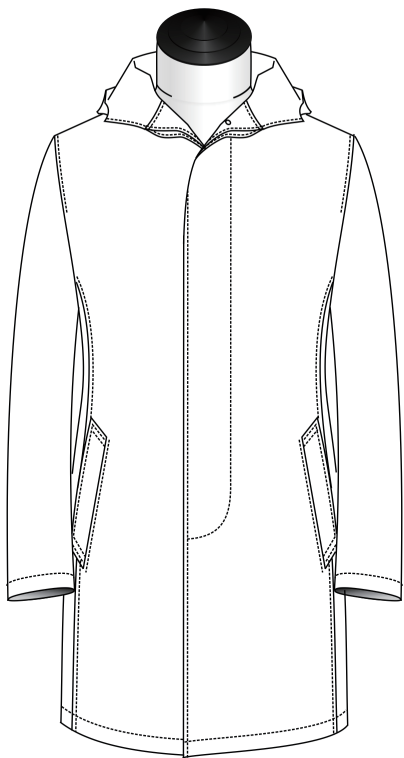

5 Button Fly Front Hooded

Side Pockets

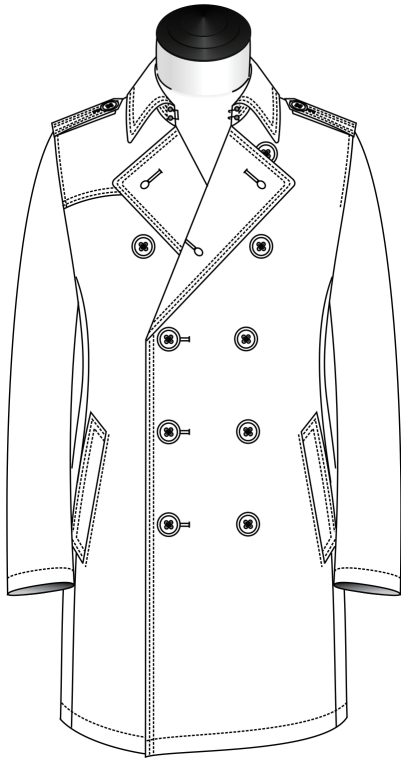

Welled

Chest Pockets

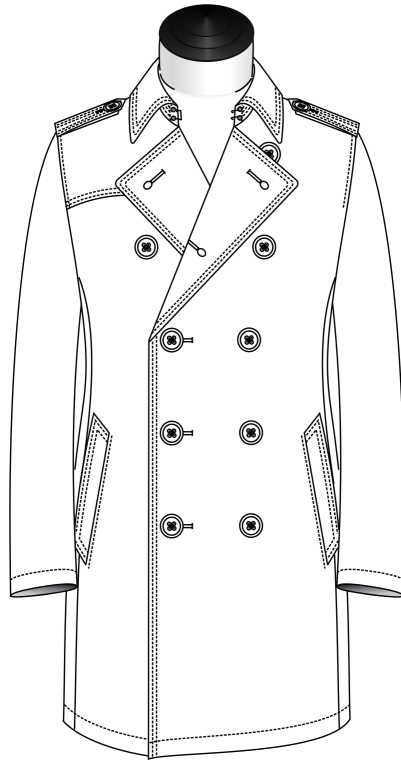

No

Vents

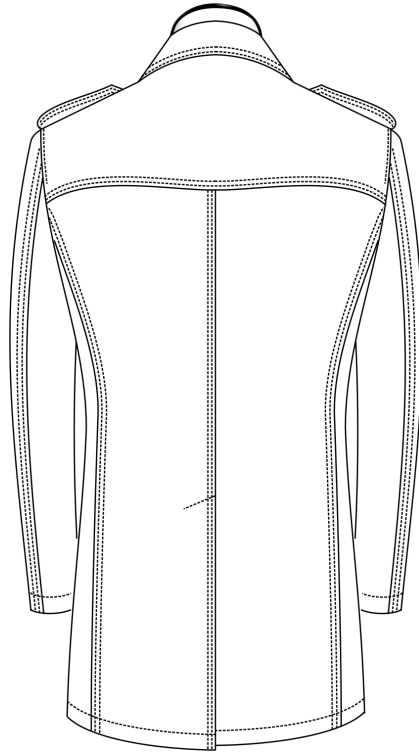

Center [1]

Belt

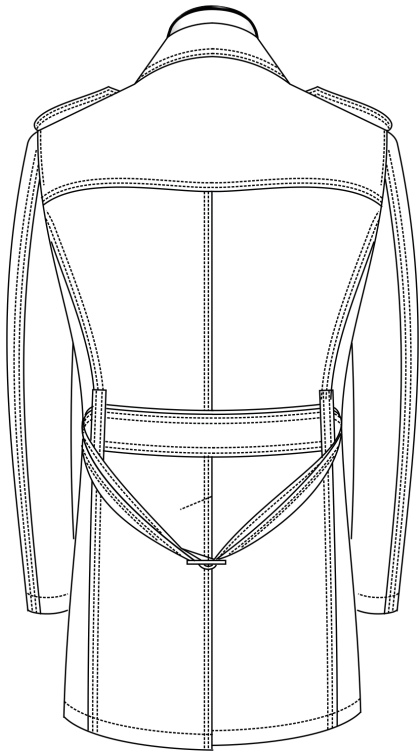

Yes

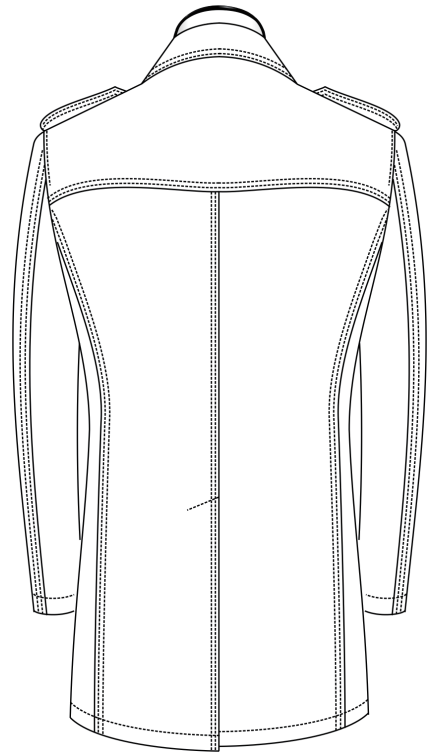

No

Cuff Finishing

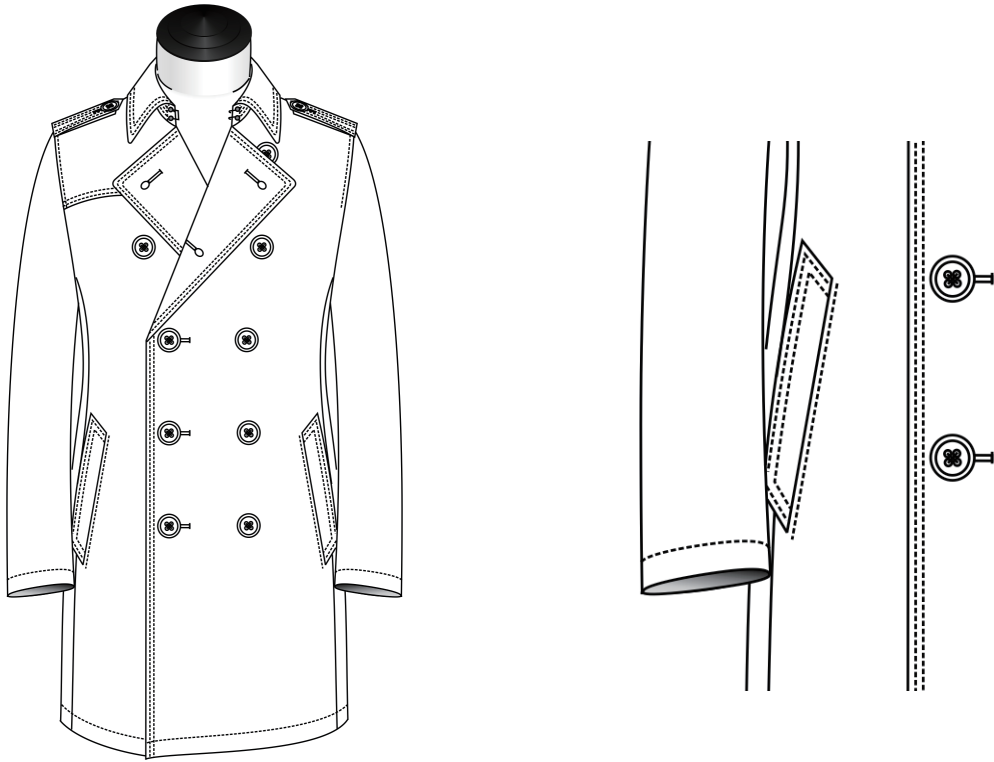

Plain Hem with 2.5cm

Cuff Tab

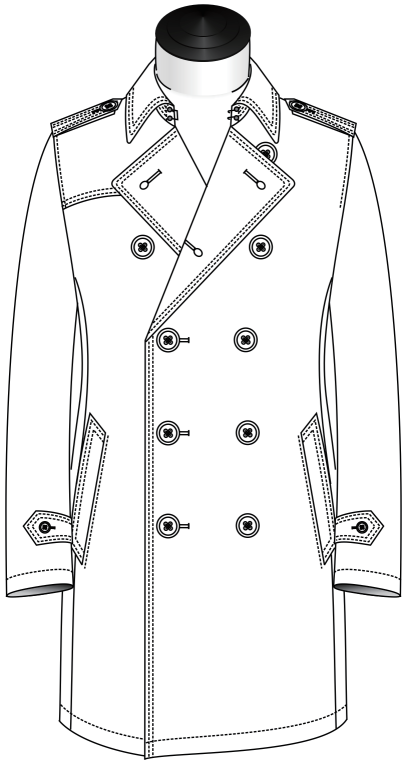

Yes

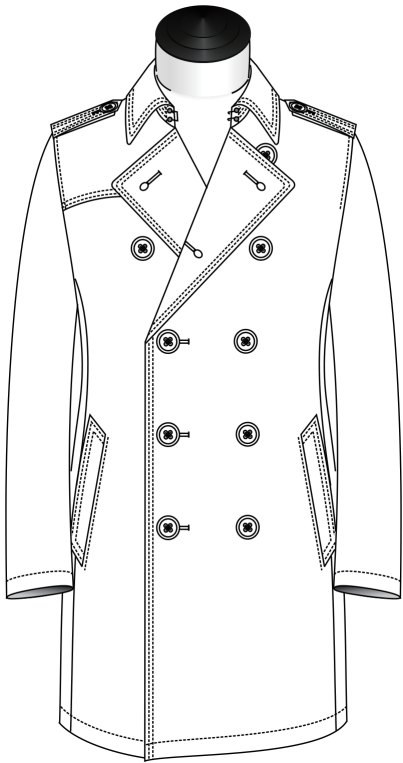
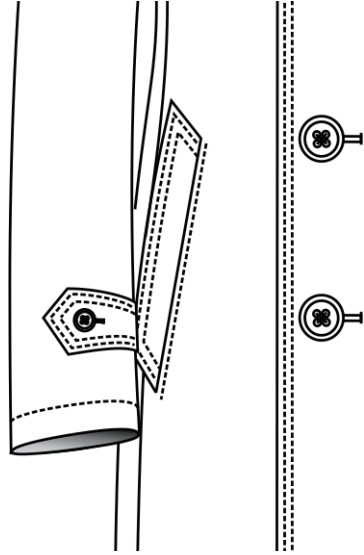

No

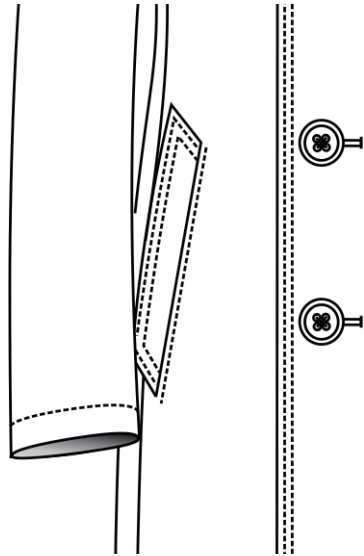

Shoulder Type

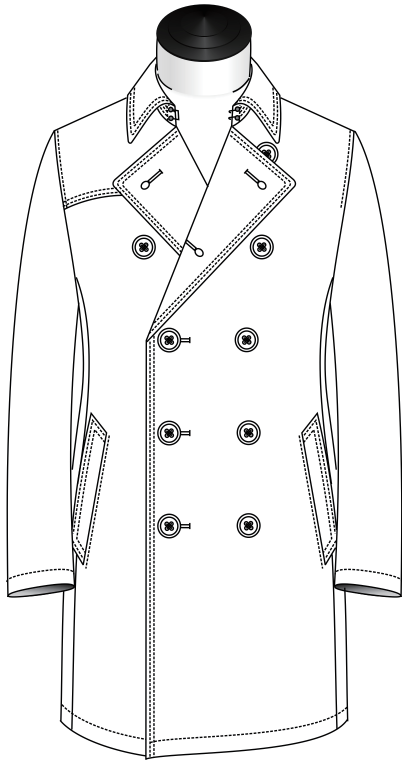

Standard

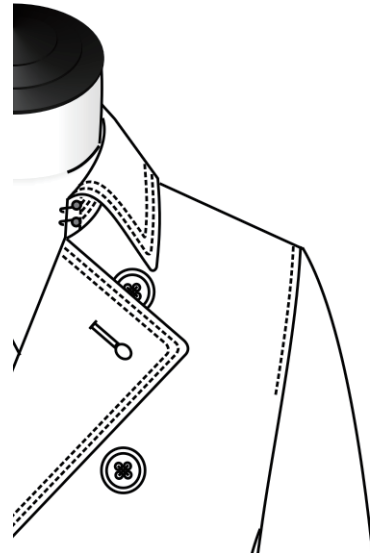

Shoulder Tab

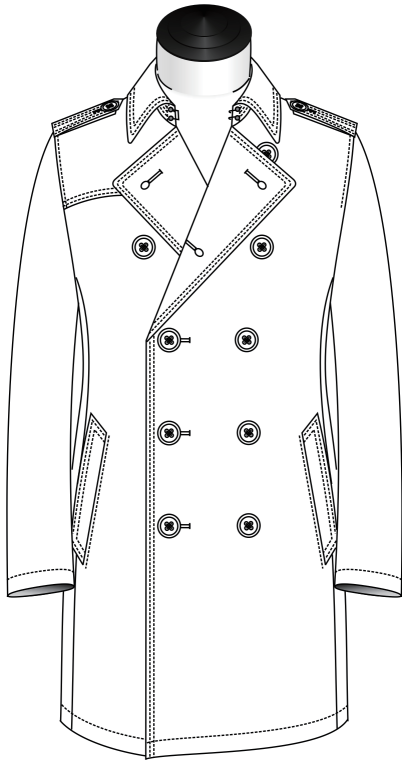

Yes

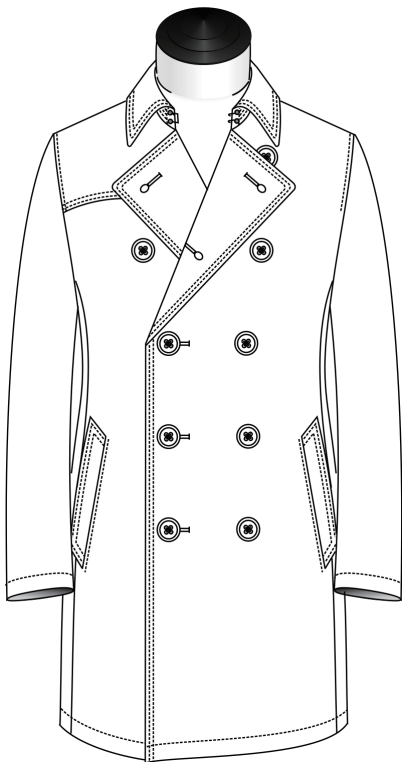
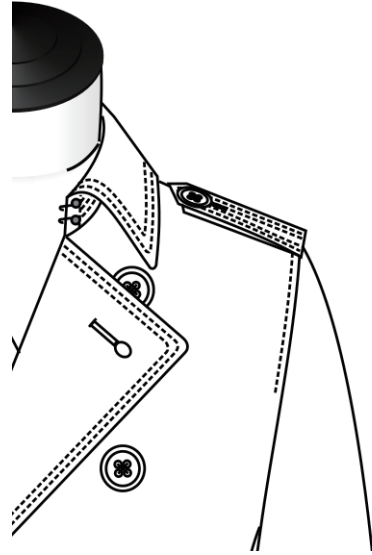

No

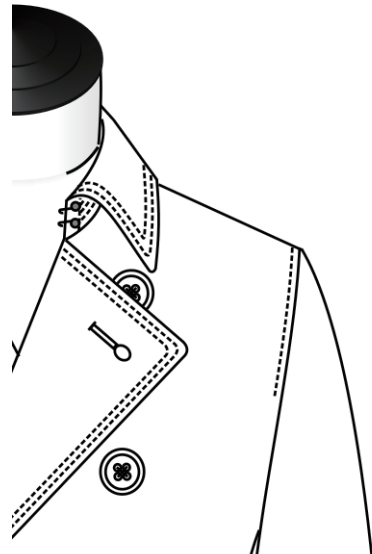

Interior Construction

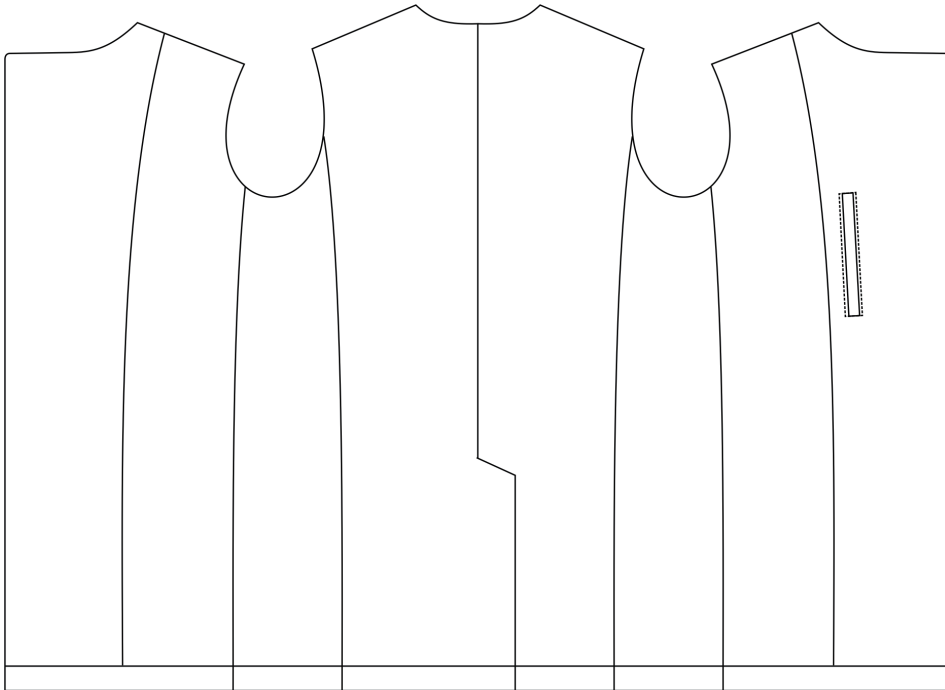

Facing Welled Pocket

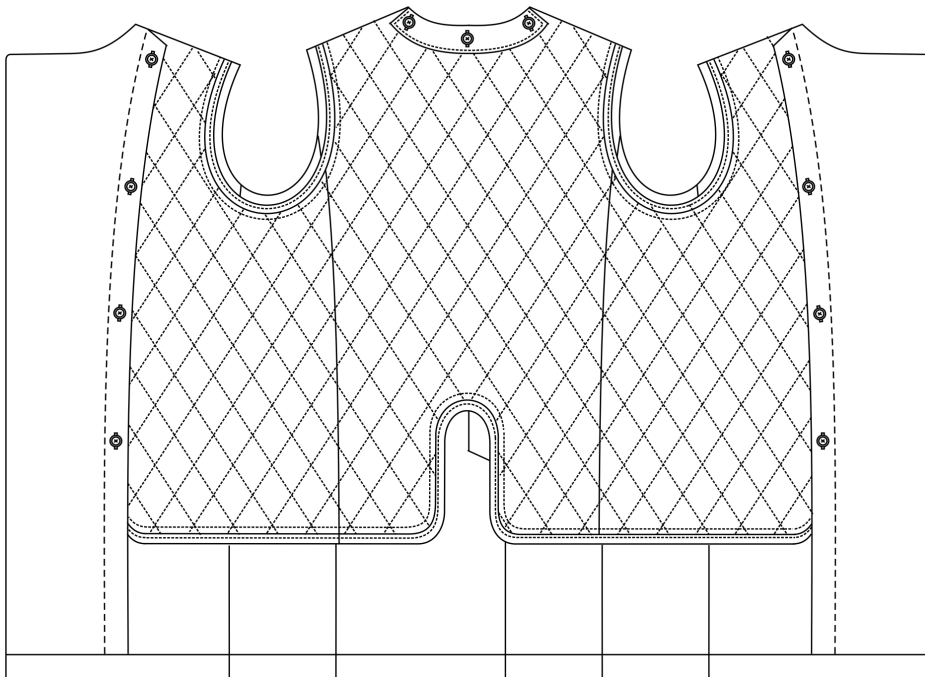

Detachable Quilted Lining

Pick Stitching



0.15cm | 1/16"



0.6cm | 1/4"

Pick Stitching



Double Stitch

Monogram Under Collar

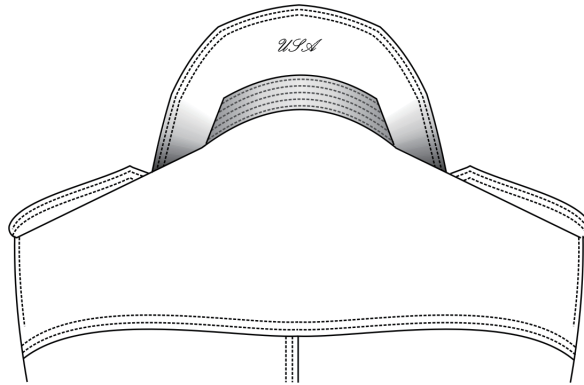
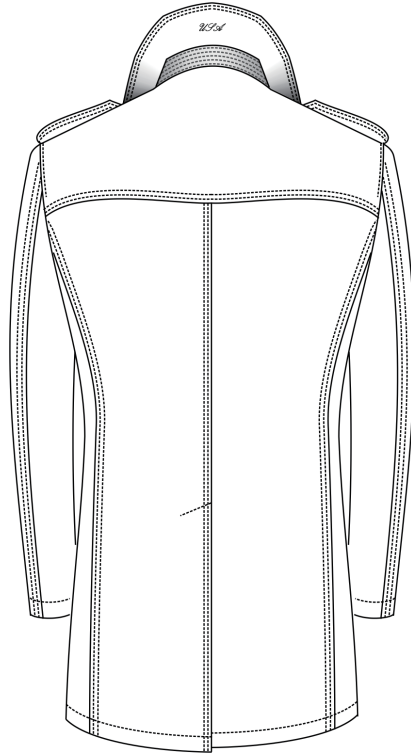

Interior Monogram

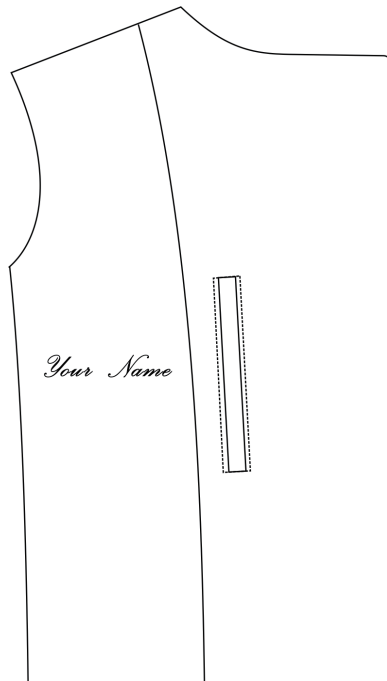

Monogram on Lining

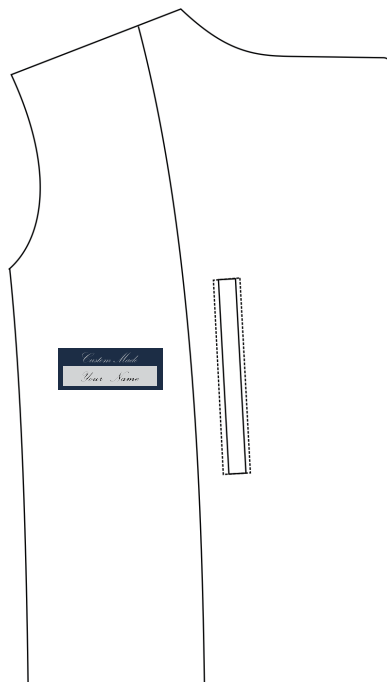

Monogram on Label